

# Radio-Electronics

THE MAGAZINE FOR NEW IDEAS IN ELECTRONICS

## COVER STORY

### DIGITAL THERMOMETER

Add it to your DMM. It reads out in °C or °F at the flip of a switch and it's a cinch to build. Turn to page 29

### DARKROOM TIMER

Digital countdown in seconds or minutes and seconds controls your enlarger. Puts your darkroom into the year 2001. Turn to page 33

### VIDEO MODULATORS

Roundup of all that we could locate. Use them to turn any TV into a video monitor. Story starts on page 38

### INVESTMENT

A computer program that lets you compare dollars in the bank with your pet investment. Story is on page 32.

### PLUS

- ★ Computer Corner  
Programmable timer
- ★ Hobby Corner  
Build expanded-scale voltmeter
- ★ Service Clinic  
Pulse-width modulated DC powersupplies
- ★ R-E Tests Revox B-760 Tuner
- ★ R-E Tests Shure V15 — Type IV Cartridge
- ★ State Of Solid State

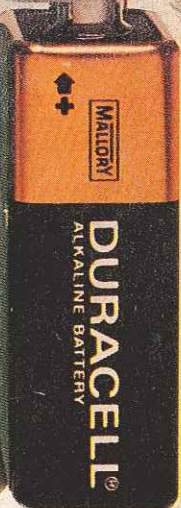
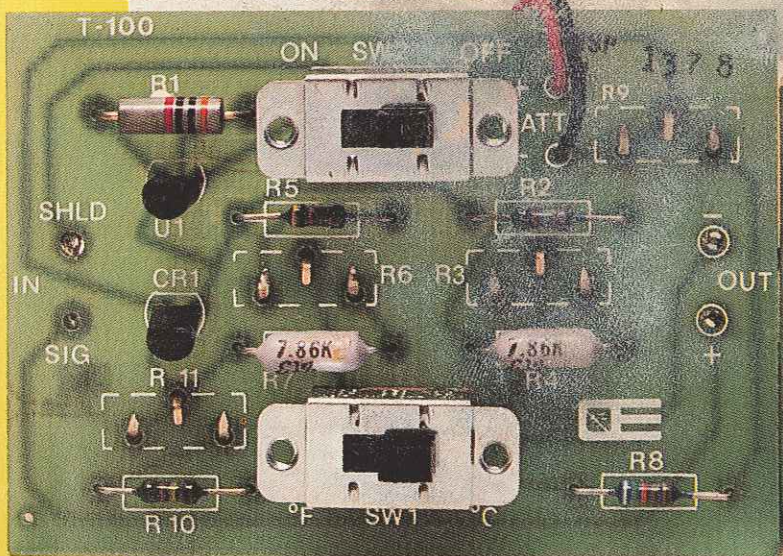

692188 JNR 11024090 14 A DEC78  
 R J JENKINS  
 1102 SOUTH 45TH ST  
 TEMPLE TX 76701  
 08

A GERNSBACK PUBLICATION

# VIDEO MODULATORS

If you are into VTR's, TV games, home computers and TV modulator must be used to feed modulated RF to

FRED BLECHMAN K6UGT

IN THE LAST TWO YEARS FOUR "NEW" ELECTRONIC PRODUCTS have been introduced into the consumer marketplace—video games, video cassette recorders, video cameras and home computers. While these products have been available in some form for several years, their design finally became practical enough for consumer acceptance. Coincidentally, each product uses a video display for its output. A TV screen is essential for playing a video game or watching a video recorder, and most home computers use a video display for the readout, although printers can also be used. Video cameras, long used for closed-circuit security and surveillance systems, are growing in popularity now that video cassette recorders are available for making home movies, and, of course, cameras also use a video display.

Two basic methods make the video signal visible on a picture tube. The most efficient method is to feed the video output of a game, camera, video recorder or computer directly into the video amplifier of a video monitor or TV set. Since most TV sets require rewiring to provide direct access to the video amplifier (and those with a hot chassis can create a dangerous shock hazard), video monitors have generally been used. However, when home video games became popular, it was obvious that the public would not care to buy a special monitor to play the games. Therefore, an old video camera technique was revived—generating an RF signal on an unused TV channel and modulating it with the video signal! By connecting the modulated RF carrier to the antenna terminals of a standard TV set, you could watch the game by simply tuning to the unused channel.

In the beginning, video game manufacturers, to avoid interfering with VHF signals, created carriers in the high UHF band. Shielding problems, signal instability with temperature variation and other design considerations caused the shift to VHF carriers modulated by the video signal. Several million video games were sold (some for as little as \$25) complete with built-in video-modulated RF oscillators. The Federal Communications Commission (FCC) then cracked down on the manufacturers, requiring them to test units to rigorous specifications before type approval was issued, in order to try minimizing the spurious radiations being generated to neighboring TV sets—or even to other sets in the home!

With technological advances taking place in the game field, microprocessors and dedicated integrated circuits (IC's) became commonplace among experimenters. Home computers suddenly blossomed from garage and basement labs to full-blown manufacturing plants. Experimenters and hobbyists found an increasing need for some means to couple the video output of their devices to a display. Video monitors have remained a low-production item and are therefore high-priced. TV set manufacturers have not recognized the sales advantage of adding a switch and jack to existing designs to allow direct video input. Therefore, there has been a steadily increasing

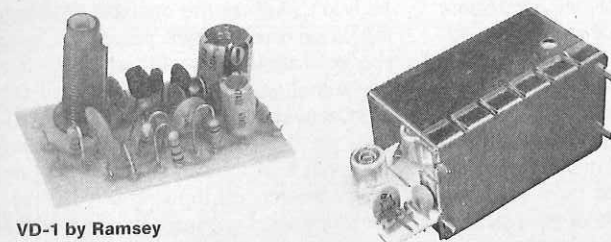

VD-1 by Ramsey

ATARI model CA-010410

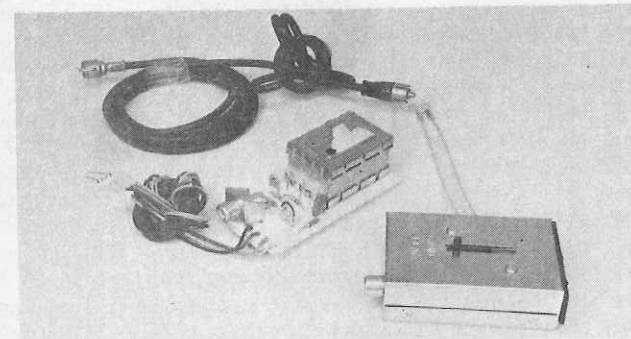

SUP "R" MOD II, cables and switch included

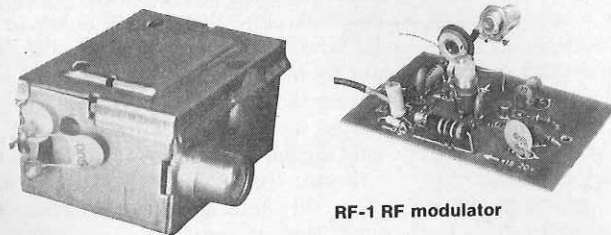

MODEL E & P

RF-1 RF modulator

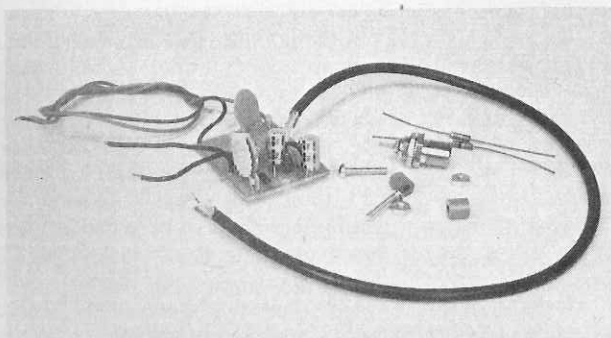

RFVM-1 sold by Vamp and Quest Electronics

## turn your TV into a video monitor

cameras in security and surveillance systems, a video TV set used as monitor. Here's what modulators are about.

market for a separate video-modulated VHF oscillator that allows the owner of a video game, camera, recorder or home computer to use the device with a standard TV set.

These VHF oscillators have many different names: RF modulator, VHF modulator, RF oscillator, video-to-TV interface, video-to-RF modulator, etc., but in this article we will use the general term of "video modulator," even though this is technically incorrect. (The device is *not* modulating the video—it is being modulated *by* the video!) Some manufacturers have sensed the need for this device among hobbyists and experimenters, and the Comparison Chart shows 14 video modulator sources. Many of these devices (and maybe others) are available at computer shops.

Figure 1 shows a simplified block diagram for a typical video

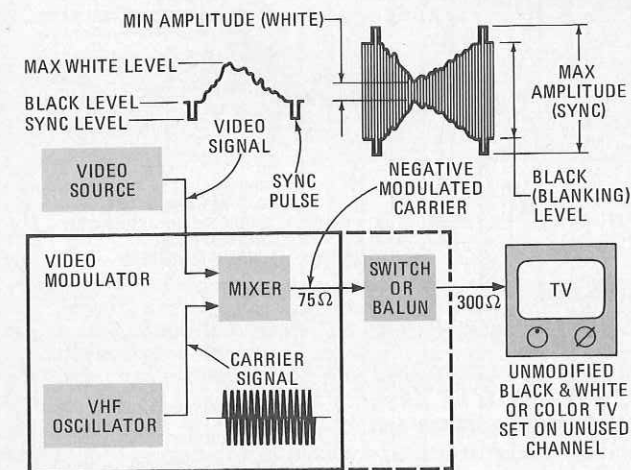
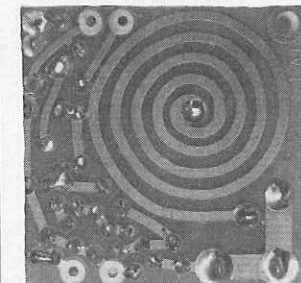
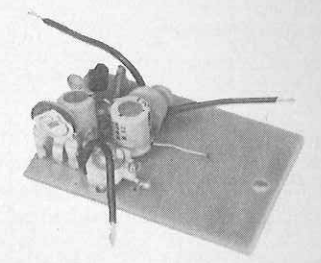

FIG. 1—BLOCK DIAGRAM OF VIDEO MODULATOR.

modulator. The video signal from the camera, computer, recorder or game should be the standard NTSC (National Television System Committee) format used in the United States, Japan, Canada and Mexico. This means that the picture carrier is modulated so a *decrease* in scene brightness causes an *increase* in output power. This is known as *negative* modulation polarity. With negative modulation polarity, the picture content may vary the transmitter output power from 15% for white level to 75% for black at the blanking level. The horizontal sync pulse rides atop the blanking pulse—extending into the blacker-than-black level at 100%. The tunable VHF oscillator generates a sinewave on a locally unused TV channel; this sinewave signal becomes the carrier. In the mixer, the video signal amplitude-modulates the VHF carrier with *negative* modulation polarity. This modulated VHF carrier connects to the antenna terminals



TV-1 video to TV interface



PXV-2A Pixe-Verter

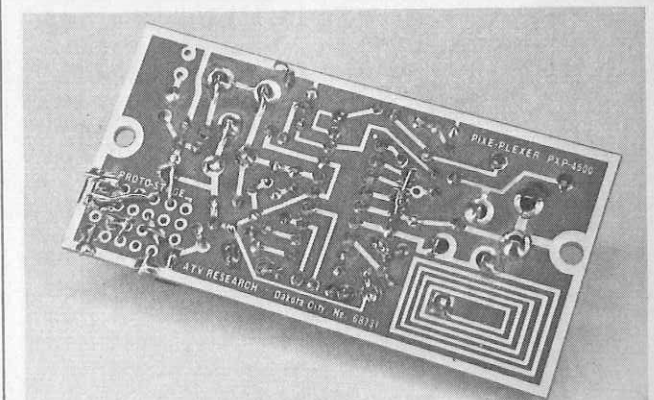

PXP-4500 Pixe-Plexer from ATV Research

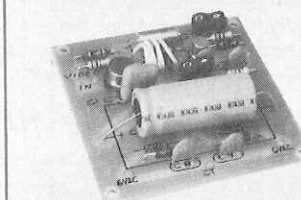

Model 1-7 RF modulator

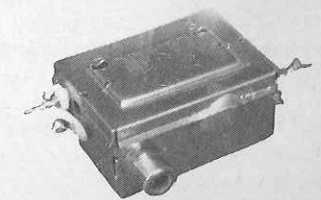

E & P video modulator

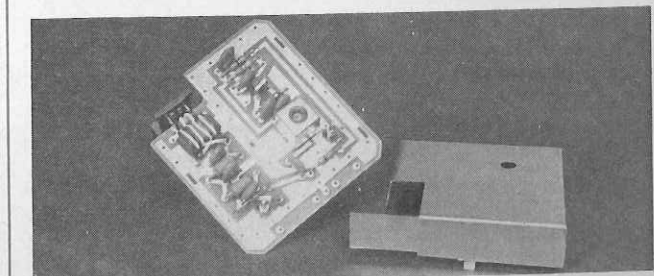

VIDEO CUBE 5500-R from Delta Electronics

COMPARISON CHART - VIDEO MODULATORS

MANUFACTURER OR DISTRIBUTOR	MODEL	PRICE (\$)		OUTPUT CHANNEL NO.			SUPPLY VOLTAGE (DC)	VIDEO INPUT CONTROL	RF-SHIELDED	INPUT CONNECTOR	OUTPUT CONNECTOR (PEAK-TO-PEAK)	PERFORMANCE					SOFTWARE			SHIPPING AND REMARKS						
		KIT	ASSEMBLED	2	3	4						5	6	MIN. VIDEO INPUT (PEAK-TO-PEAK)	RF REJECTION	VIDEO CAMERA	VIDEO RECORDER	MICROCOMPUTER	SIZE (CM.)			DOCUMENTATION	SCHEMATIC	USE DIRECTIONS	PRECAUTIONS	
																			LENGTH		WIDTH					HEIGHT
ADVANCED COMPUTER PRODUCTS P.O. BOX 17329 IRVINE, CA 92713	U1001 RF MODULATOR WITH AUDIO	—	7.95	✓	✓		9	N	Y	N	①	②	P	G	G	P	8	5.5	2.5	P	N	N	N	SHIPPING: 5% + \$.50 INSUR. CAL. RES. ADD 6% TAX. OUTPUT INVERTED. SEE TEXT.		
ADVANCED VIDEO PRODUCTS 5835 HERMA SAN JOSE, CA 95123	RF-1 RF MODULATOR	12.00	—	✓	✓	✓	9-20	Y	N	N	N	.4	G	E	E	G	8.3	5.2	2.5	G	Y	Y	N	SHIPPING: C.O.D. CHARGE. CAL. RES. ADD 6% TAX. TUNING WAND INCLUDED.		
ATV RESEARCH 13TH AND BROADWAY DAKOTA CITY, NE 68731	PXV-2A PIXE-VERTER	8.50	—	✓	✓	✓	-5 TO -6.5	Y	N	N	N	2	F	G	G	F	5.1	3.2	2.0	E	Y	Y	Y	SHIPPING: POSTPAID. NEGATIVE SUPPLY VOLTAGE REQUIRED.		
	PXP-4500 PIXE-PLEXER	24.50	—	✓	✓	✓	15	N	N	N	N	④	G	G	G	G	7.7	3.8	2.3	E	Y	Y	Y	SHIPPING: POSTPAID AUDIO INCLUDED.		
CALIFORNIA INDUSTRIAL P.O. BOX 3097K TORRANCE, CA 90503	CA-010410 ATARI RF MODULATOR	—	13.95	✓	✓		1.5-12	N	Y	N	①	.8	F	E	E	G/F	6.5	3.2	2.8	P	Y	N	N	SHIPPING: \$1 FOR ORDERS UNDER \$15. CAL. RES. ADD 6% TAX. WILL OPERATE ON PEN CELL. 15 FT. COAX & RF CONNECTOR INCLUDED.		
DELTA ELECTRONICS 7 OAKLAND ST. AMESBURY, MA 01913	5500R VIDEO-CUBE	13.95	—	✓	✓		5-12	N	Y	N	N	4	P	F	F	P	6.3	5.6	2.8	G	Y	Y	Y	SHIPPING: POSTPAID. MASS. RES. ADD SALES TAX. MUST BE TAILORED TO CIRCUIT - SEE TEXT.		
ELECTRONIC SYSTEMS P.O. BOX 212 BURLINGAME, CA 94010	NO. 107 RF MODULATOR	13.50	—	✓	✓		5VDC OR 12VAC CT	N	N	N	N	2	G	E	E	F	6	6	1.5	F	Y	N	N	SHIPPING: POSTPAID WHEN PAYMENT SENT WITH ORDER. CAL. RES. ADD 6% TAX. PC BOARD ALONE: \$7.60.		
FORMULA INTERNATIONAL, INC. 12603 CRENSHAW BLVD. HAWTHORNE, CA 90250	VHF MODULATOR (E&P)*	—	4.50	✓			5-6.5	N	Y	N	①	②	②	③	③	③	6	3.8	2.4	P	N	Y	N	SHIPPING: 10% OUTSIDE CAL. CAL. RES. ADD 6% TAX. MIN. ORDER: \$10. OUTPUT INVERTED - SEE TEXT.		
BILL GODBOUT ELECTRONICS OAKLAND AIRPORT CA 94614	RF MODULATOR (E&P)*	—	7.50	✓			5-6.5	N	Y	N	Y	②	②	③	③	③	6	3.8	2.4	NO DOCUMENTATION RECEIVED WITH UNIT			Y	N	SHIPPING: \$.50. CAL. RES. ADD 6% TAX. OUTPUT INVERTED - SEE TEXT.	
JADE COMPUTER PRODUCTS 5351 WEST 144TH ST. LAWDALE, CA 90260	TV-1 VIDEO-TO-TELEVISION INTERFACE	8.95	—	✓	✓	✓	5-12	Y	N	N	N	.25	G	E	E	G	3.5	3.5	1.5	E	Y	Y	Y	SHIPPING: \$1.25. CAL. RES. ADD 6% TAX. (MADE BY UHF ASSOCIATES) SMALLEST UNIT. COAX INCLUDED.		
M & R ENTERPRISES P.O. BOX 61011 SUNNYVALE, CA 94088	SUP "R" MOD II TV INTERFACE	—	29.95	✓			12	Y	Y	①	①	2	G	G	G	G	8.2	3.9	2.5	E	Y	Y	Y	SHIPPING: \$1. CAL. RES. ADD 6% TAX. TV SWITCH & COAX INCLUDED.		
QUEST ELECTRONICS P.O. BOX 4430E SANTA CLARA, CA 95054	VIDEO MODULATOR (TV-1)	8.95	—	✓	✓	✓	5-12	Y	N	N	N	.25	E	E	E	G	3.5	3.5	1.5	E	Y	Y	Y	SHIPPING: POSTPAID. CAL. RES. ADD 6% TAX. SEE JADE MODEL TV-1 FOR TEXT. COAX INCLUDED.		
	VIDEO MODULATOR (RFVM-1)	8.95	—	✓	✓	✓	5	Y	N	N	⑤	.8	G	E	E	F	4.5	3.3	2	E	Y	Y	Y	SHIPPING: POSTPAID. CAL. RES. ADD 6% TAX. SEE VAMP MODEL RFVM-1 FOR TEXT. MOUNTING HARDWARE, COAX & CONNECTOR INCLUDED.		
RAMSEY ELECTRONICS P.O. BOX 4072 ROCHESTER, NY 14610	VD-1 VIDEO-TO-RF MODULATOR	6.95	—	✓	✓	✓	5-10	N	N	N	N	.5	F	G	G	F	4.6	2.6	2.5	G	Y	Y	N	SHIPPING: \$.75 FOR ORDERS UNDER \$10. N.Y. RES. ADD 7% TAX. LEAST EXPENSIVE KIT.		
UHF ASSOCIATES P.O. BOX 24 JENNER, CA 95450	TVS-100	⑥	⑥	✓	✓		15-20	Y	Y	①	①	1	G	E	E	G	16	5	2	⑥	⑥	⑥	⑥	⑥ AUDIO INCLUDED.		
VAMP, INC. P.O. BOX 29315 LOS ANGELES, CA 90029	RFVM-1 RF-TO-VIDEO MODULATOR	8.95	—	✓	✓	✓	5	Y	N	N	⑤	.8	G	E	E	F	4.5	3.3	2.0	E	Y	Y	Y	SHIPPING: \$1 FOR ORDERS UNDER \$15. CAL. RES. ADD 6% TAX. MOUNTING HARDWARE, COAX & CONNECTOR INCLUDED.		

NOTES: E=EXCELLENT G=GOOD F=FAIR P=POOR Y=YES N=NO \*E&P STAMPED ON CASE IS ONLY IDENTIFICATION  
 ① RCA PHONO JACK. ② NOT TESTED - SEE TEXT. ③ UNIT WILL NOT WORK WITH NTSC VIDEO - SEE TEXT. ④ VARIES WITH INTERFACE CIRCUIT.  
 ⑤ F-59 CONNECTOR SUPPLIED. ⑥ INFORMATION NOT AVAILABLE. WRITE COMPANY FOR SPECIFICATIONS, PRICE AND AVAILABILITY.

of a standard black-and-white or color TV set. When the TV set is tuned to the VHF carrier frequency, the information contained on the video signal is displayed conventionally. For most units tested, a TV antenna switch or a balun transformer (75 ohms to 300 ohms) is needed for connection to the TV antenna terminals.

**Evaluating the modulators**

Bob Buckner, an electronics consultant, built all the kit units reported on, and did the majority of the data compilation. He and I did the comparative testing together. Gene Hill, co-owner of UHF Associates, provided most of the units for building and testing, with the understanding that the "chips fall where they may" in the evaluations. (As it turned out, the two UHF Associates units were outstanding, and the reader will have to take my word that my objectivity was not influenced by the cooperation of UHF Associates!)

Twelve different video modulator designs were examined for this article, although some were available from more than one source. Each design was different in circuitry, layout and components, although some similarities existed. Two sources distribute the E & P unit: Formula International, Inc., and Godbout Electronics. Although this was the least expensive assembled unit, it appears to be wired for a positive-sync, video input signal, since we could not receive anything except a negative picture that would not synchronize with the TV. Inverting the input video signal with a properly biased transistor circuit would probably allow this unit to be used with a standard TV set. However, this was not tried.

Figure 2 shows the schematic of the UHF Associates model

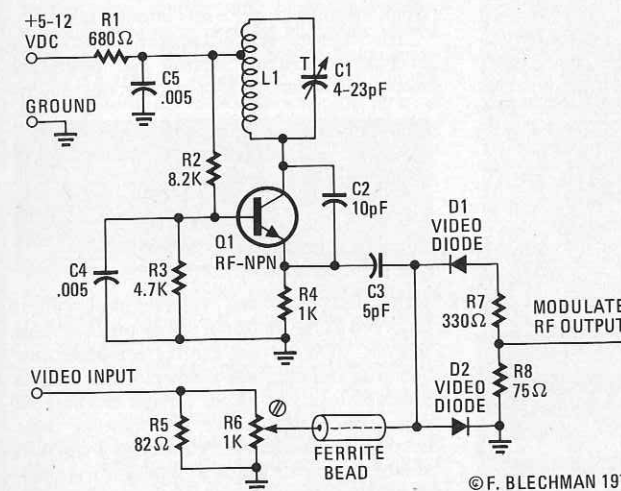

FIG.2—UHF ASSOCIATES MODEL TV-1 schematic diagram.

TV-1 modulator, distributed by Jade Computer Products and Quest. The VHF frequency is generated by a tuned Hartley oscillator circuit. Resistors R2, R3 and R4 bias the transistor, with tapped printed-circuit inductor L1 and trimmer capacitor C1 forming the tank circuit. Adjusting C1 determines the frequency. Capacitor C2 provides positive feedback from the tank circuit to the emitter at Q1. Capacitor C4 provides an RF ground for the base of Q1. Bypass capacitor C5, together with resistor R1, filters the radio frequencies generated in the tank circuit to prevent radiation from the power-supply lines.

The video signal enters the parallel combination of resistors R5 and R6; this combination closely matches the 75-ohm impedance of most video cables. Resistor R6 is a small screwdriver-adjusted potentiometer that is used to control the video input level to mixer diodes D1 and D2. These diodes are operated in their nonlinear region to mix the video signal with the VHF carrier. With no video input, the VHF carrier, which is loosely coupled to the mixer by capacitor C3, passes through D1 to voltage divider R7-R8. The output impedance is 75 ohms, to match standard video coaxial cable. As the video signal leaves video level control R6, it encounters the ferrite bead; this bead

blocks any RF on the video-input line, yet passes the video signal on to diodes D1 and D2. This video signal effectively biases the diodes, allowing them to conduct or block the carrier signal, thus modulating the carrier. For example, as the video signal amplitude goes positive, D2 is forward-biased toward ground, so the carrier amplitude is decreased. However, as the video signal goes negative, and grows even more negative to the sync level, D2 cuts off and the maximum carrier amplitude (minus the diode voltage drop) passes through D1 to R7-R8. Therefore, white-level video signals yield the lowest VHF carrier output, and sync pulses are the highest, as shown in Fig. 1!

**Comparison chart**

The sources, prices and shipping information shown in the Comparison Chart were correct as of early March, 1978. The output channels and supply voltages are those specified in manufacturer's literature. Some units might be tunable beyond the specified channels. The supply voltages are all positive, except for ATV's *Pixe-Verter*, which requires a negative voltage. The video input on those units designated in the chart with a "Y" (for "Yes") consists of a small potentiometer, usually with a screwdriver slot for adjustment. Most units do not have video input or VHF output connectors, this being left up to the user's discretion to suit a particular application. Those units that do have connectors use standard RCA phono jacks, except for the Vamp unit, which has one F-59-type RF connector supplied with the kit.

The performance parameters were judged based on comparisons with other units. The peak-to-peak video voltage was measured using an oscilloscope, with the "minimum" standard being that point below which the picture quality was noticeably affected. For those units with a listed voltage range, the test was conducted at the minimum voltage.

Since a video modulator might be operated in or near a computer terminal, each modulator was used to display a color signal while near a Radio-Shack TRS-80 computer, and the interference from the computer was evaluated. In many cases, the interference was hardly noticeable, even though most units were unshielded and clip leads were used for making some connections. Probably if shielded wire and connectors are used and a metal enclosure is placed around each unit, the RF interference from the computer would not be a problem.

The most difficult judgment involved was that of picture quality using a black-and-white video camera and a color TV video signal. The camera was an FS II from Advanced Video, and all the negative-sync-output modulators provided good to excellent results, except for the *Videocube*. The *Videocube* requires special matching, depending on the mating circuits, and the results could probably be improved by further refinements.

The color video source was the video output of an RCA *SelectaVision* video cassette recorder, and most units provided a surprisingly good picture. In some cases, jockeying of video input level and supply voltage was required; once tuned properly, however, the color and contrast were good. Again, the exceptions were the positive-sync units, which were unusable with a standard video signal.

The test that really "separated the men from the boys" was when we tried to receive a video signal from a computer through the TV front end! The Radio Shack TRS-80 computer was used with each video modulator and displayed on a Midland model 15-023 12-inch black-and-white TV set. The computer produces 16 lines at 64 characters-per-line, and the results were compared with a direct video connection to the TRS-80 12-inch black-and-white video monitor. Under no conditions in our tests could a video modulator duplicate the clarity that was obtained by this direct connection to the video monitor. This is not really surprising when you consider that the effective video bandpass of even a good TV receiver is no more than 4.0 MHz, while the video monitor is rated at 5.5-MHz maximum bandwidth.

Next month we'll continue this discussion and then take a detailed look at the products of each manufacturer as listed in the comparison chart.